

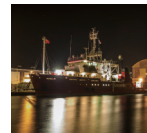

# ADMIRAL

## MARINE LIGHTING

### KAP-ADM



## Electrical / Electrique

	ADMIRAL 50	ADMIRAL 100	ADMIRAL 200
Power / Puissance	47.5 W	98.5 W	197 W
Input voltage / Tension d'entrée	100 - 277 VAC or/ou 9 ~32V DC	100 - 277 VAC	100 - 277 VAC
Frequency / Fréquences	50 - 60 Hz	50 - 60 Hz	50 - 60 Hz
Power factor / Facteur de puissance	> 0.94	> 0.94	> 0.94

## Lighting / Eclairage

	ADMIRAL 50	ADMIRAL 100	ADMIRAL 200
Beam angle / Angle de faisceau	See Option	See Option	See Option
Efficiency / Efficacité	140 Lumens/w	127 Lumens/w	127 Lumens/w
Lumen output / Sortie lumens	6000 Lumens	13000 Lumens	26000Lumens
CRI / IRC	>70	>70	>70
Color temperature / Température de couleur	5000 K	5000 K	5000 K

## Components & fixture / Composants et structure

Body material / Matériau du corps du projecteur	Aluminum / Aluminium
Coating / Enrobage	Marine grade hard anodizing and pvdf
Bracket material / Matériau de l'étrier	Stainless steel 304 / Acier inoxydable 304
Screws material / Matériau des visseries	Stainless steel 316 / Acier inoxydable 316
Optics / Optique	Anti-UV Polycarbonate
Cable specifications / Spécifications du cable	HO5RNF (3C*1.0mm <sup>2</sup> )
LED Chipset / Puces LED	OSRAM
Cable length / Longueur du cable	0.5m

## Temperatures / Températures

Storage temperature / Température de stockage	-40°C ~ +80°C
Operating temperature / Température d'utilisation	-30°C ~ 50°C
Storage Humidity / Humidité de stockage	10% - 90%

## Additional product data / Informations supplémentaires

Lifetime / Durée de vie	54000 Hours @ 50°C
Warranty / Garantie	5 years / 5 ans
Wind Resistance / Résistance au vent	Up to 60m/s (216km/h)
Surge Protection / Protection contre les surtensions	4kV / 2kV

## Model number / Numéro de référence

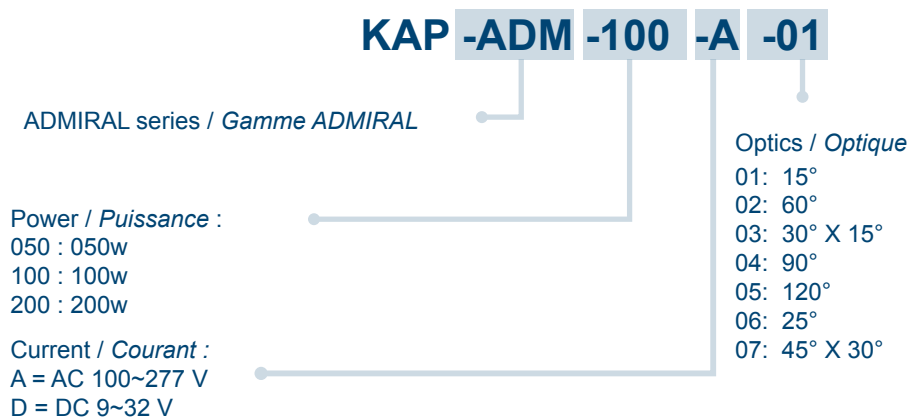

## Product Dimensions

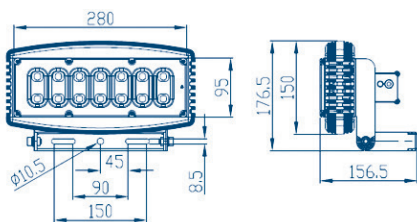

ADMIRAL 50

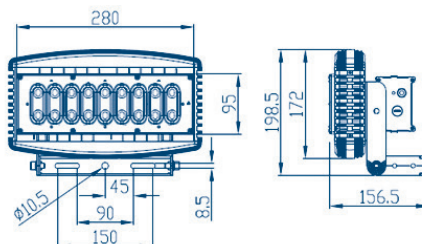

ADMIRAL 100

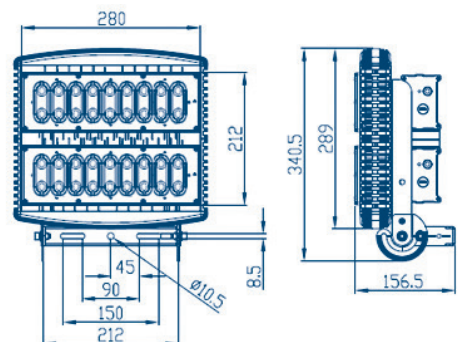

ADMIRAL 200

# Photometry / Photométrie

15°

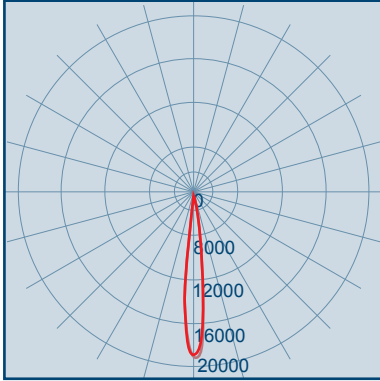

60°

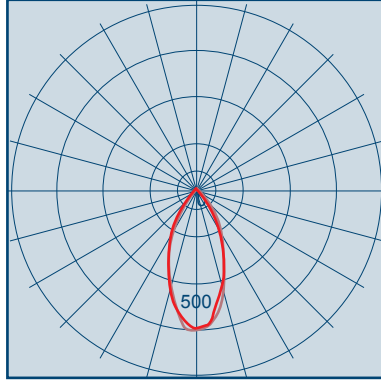

30° X 15°

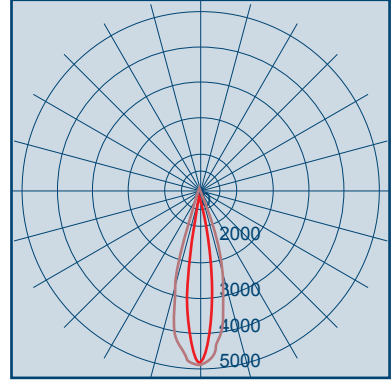

90°

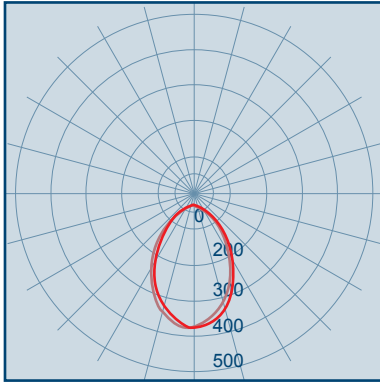

120°

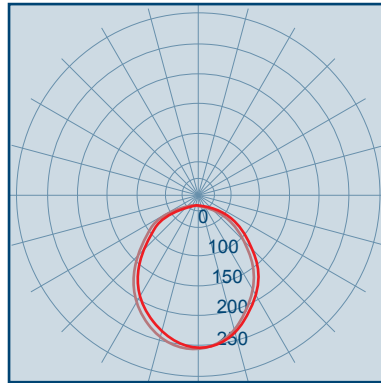

25°

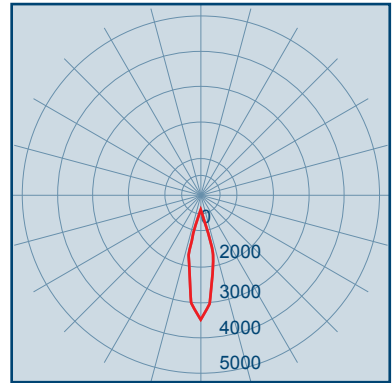

45° X 30°

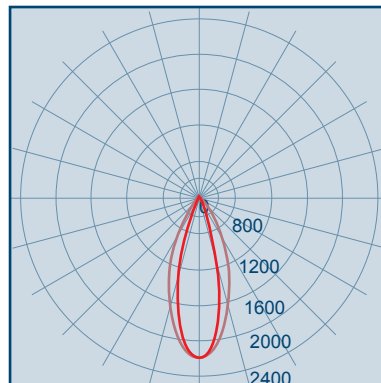

## Packing Information / Information Colisage

### ADMIRAL 50

Packing details	Size (mm)	Qty / ctn(pcs)	Net Weight (kg)	Gross Weight (kg)
Product	245*305*128	/	2.3	/
Inner box	395*255*255	1	/	2.9

### ADMIRAL 100

Packing details	Size (mm)	Qty / ctn(pcs)	Net Weight (kg)	Gross Weight (kg)
Product	267*305*135	/	3	/
Inner box	395*255*255	1	/	3.7

### ADMIRAL 200

Packing details	Size (mm)	Qty / ctn(pcs)	Net Weight (kg)	Gross Weight (kg)
Product	341*305*135	/	5.6	/
Inner box	425*405*255	1	/	7.0